

# Straight Tension Fabric Backdrop

## Assembly Instructions

1. Top Corner Poles (x2)
2. 4pc Top Pole
3. 4pc Bottom Pole
4. Bottom Corner poles (x2)
5. Graphic
6. Fleet (x2)
7. 3pc Left Pole
8. 3pc Right Pole
9. 4pc Vertical Center Pole

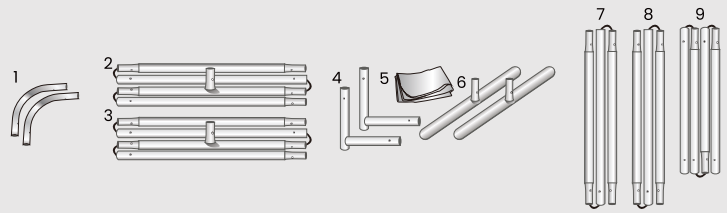

### 1 Parts Removing

Remove all parts from the carrying case and lay them out on a clean flat surface. Make sure you have all the components listed above.

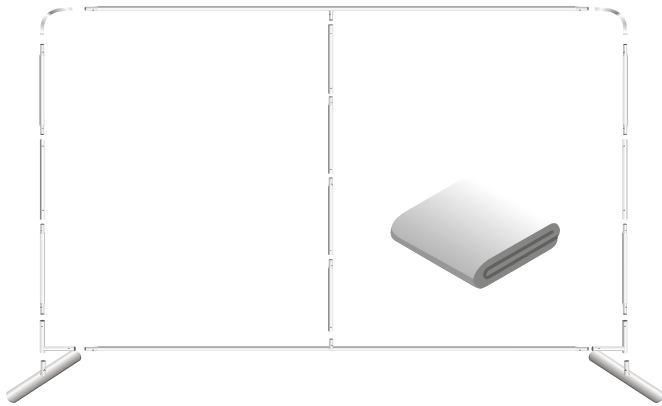

### 2 Assemble The Frame

Connect all of the poles together by matching each number to its counterpart.

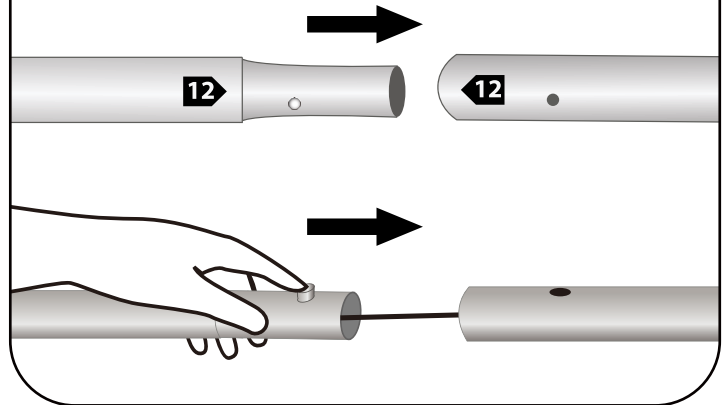

### 3 Install The Counter Top

Continue to connect the poles illustrated in the image below.

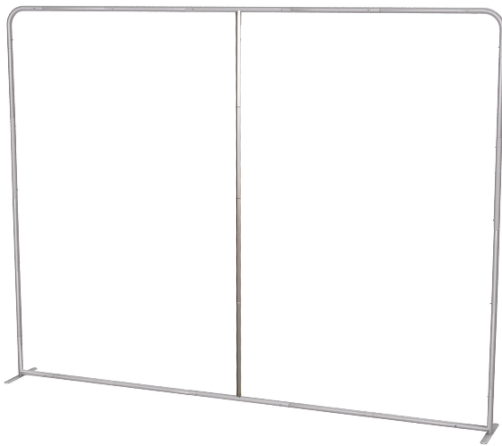

### 4 Install The Graphic

Pull down the graphic from top to bottom and zip up

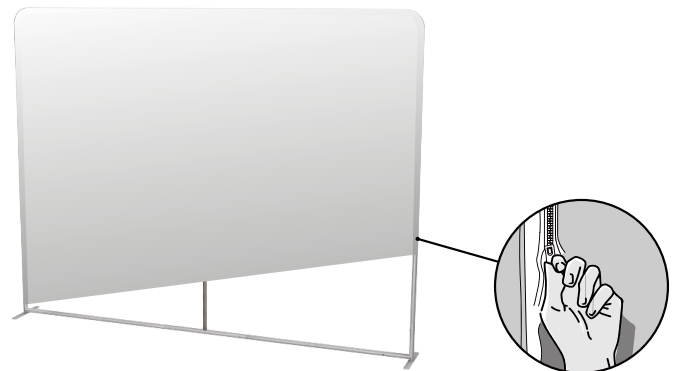

### Storage & Care:

Store in a cool dry location. Clean hardware with a damp cloth. Machine wash the graphics in cold water on a gently cycle. Air dry only. Use a steamer for wrinkles. Never dry-clean.

# Hard Case Podium

## Assembly Instructions



(1) Case Shell  
(top)



(1) Case Shell  
(bottom)



(1) Counter Top



(4) Poles



(1) Podium Graphic

### 1 Assemble the Frame

Place Case Shell (bottom) flat on the floor and insert the poles into each of the holes. Then align Case Shell (top) over the poles and press firmly into place.



### 2 Install Podium Graphic

Starting at the base pull the Podium Graphic the Case Shell (bottom). Then pull up over Case Shell (top), one corner at a time. Adjust and straighten as needed then zip up the back.



### 3 Install The Counter Top

Place the counter top over Case Shell (top) and press down to ensure the grooves fit over the edge of the case.

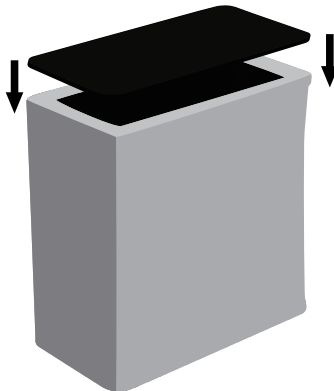

### 4 Hidden Storage

Use the inside of the podium as an extra storage space for marketing collateral or personal items by unzipping the back and placing items inside.

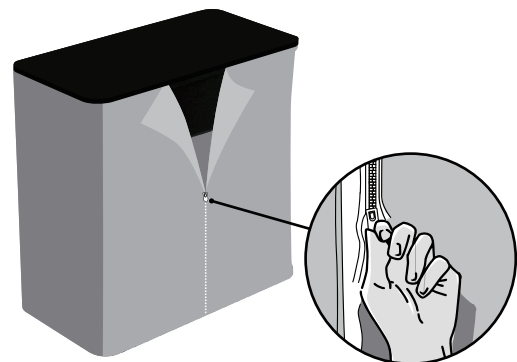

### Storage & Care:

Store in a cool dry location. Clean hardware with a damp cloth. Machine wash the graphics in cold water on a gently cycle. Air dry only. Use a steamer for wrinkles. Never dry-clean.

# Media Rack

## Assembly Instructions

1. Curved Base (2)
2. Corded Vertical Side Poles (2)
3. Top End Cap Pole (1)
4. Bottom End Cap Pole (1)
5. Media Rack Support Pole (1)
6. Media Mount (1)
7. Screw (1)
8. Literature Rack Clips (4)
9. Literature Rack (2)
10. Media Rack Graphic

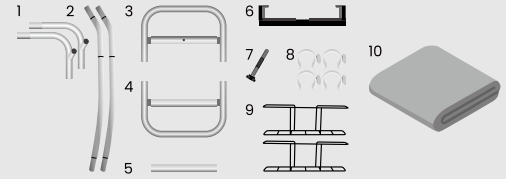

### 1 Assemble The Frame

Connect the poles by matching the numbers.

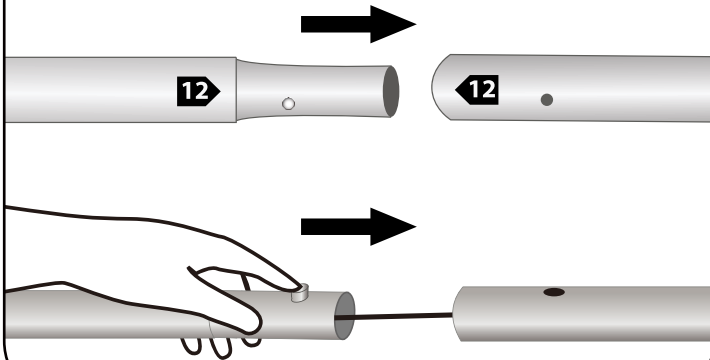

### 2 Install The Media Rack Graphic

Carefully pull the Media rack Graphic (10) over the frame, ensuring both sides are pulled down at the same time. Zip the end to secure the graphic.

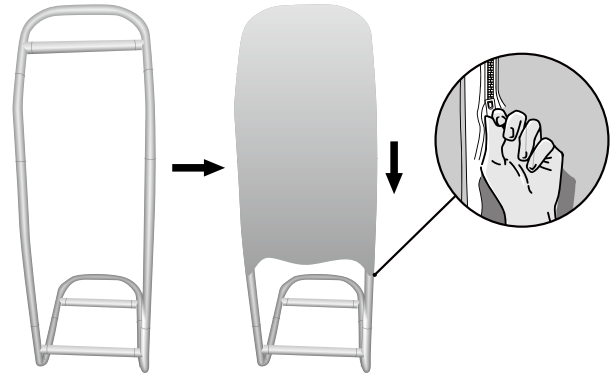

### 3 Install The Media Mount

Install the Media Mount (6) by running the Screw (7) through the back of the stand, through the hole in the Media Rack Support Pole (5). Tighten Screw into the back of Media Mount to secure in place.

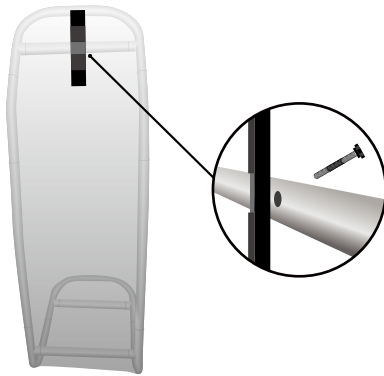

### 4 Install Literature Rack Clips

Install Literature Rack Clips (4) on each of the side bars. Hand Literature Rack from the clips.

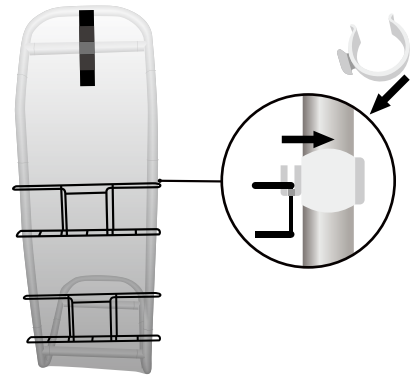

### Storage & Care:

Store in a cool dry location. Clean hardware with a damp cloth. Machine wash the graphics in cold water on a gently cycle. Air dry only. Use a steamer for wrinkles. Never dry-clean.

# Tension Fabric Header

## Assembly Instructions



(2) Side Poles



(2) Top & Bottom Poles



(2) Short Clamps



(1) Allen Key

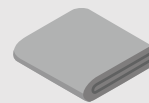

(1) Header Graphic

### 1 Assemble the Frame

Connect the poles by matching the numbers.

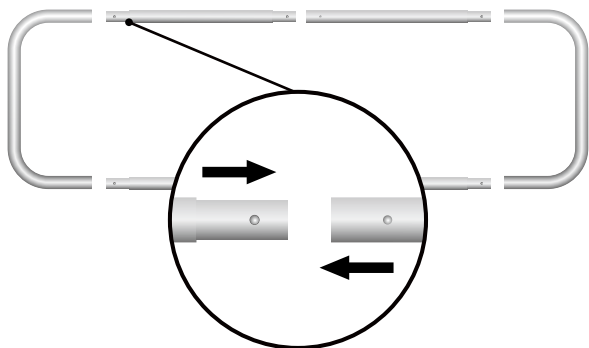

### 2 Install the Graphic

Carefully pull the graphic print over the frame, ensuring both sides are pulled down at the same time.

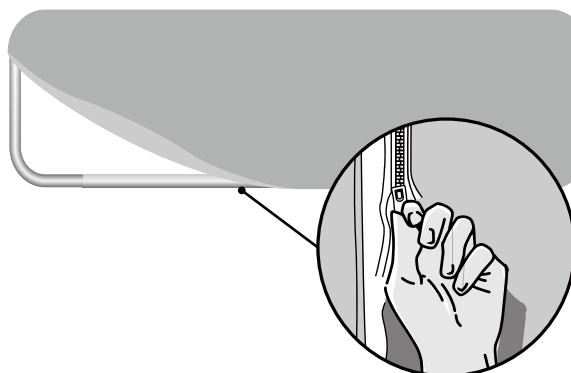

- 3** Lay the header and backdrop flat on the floor. Attach the Header to Backdrop by aligning the header to the desired position on the backdrop and locking into place with the short clamps. (use allen key to tighten everything down)

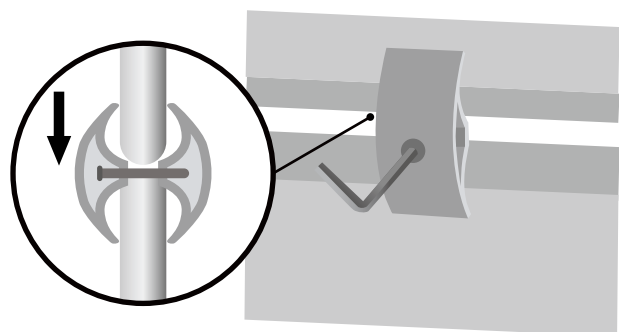

- 4** Carefully lift the backdrop and with header back to the standing position.

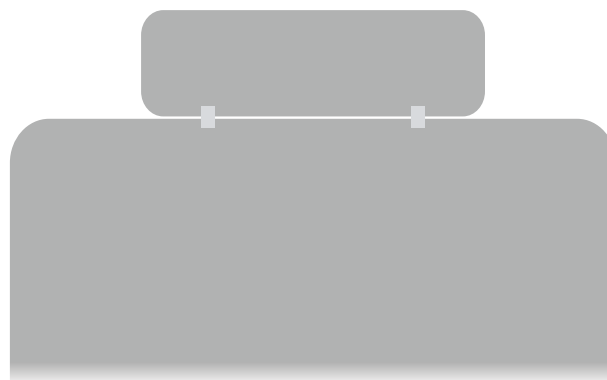

### Storage & Care:

Store in a cool dry location. Clean hardware with a damp cloth. Machine wash the graphics in cold water on a gently cycle. Air dry only. Use a steamer for wrinkles. Never dry-clean.