

Straight Tension Fabric Backdrop

Assembly Instructions

1. Top Corner Poles (x2)
2. 4pc Top Pole
3. 4pc Bottom Pole
4. Bottom Corner poles (x2)
5. Graphic
6. Fleet (x2)
7. 3pc Left Pole
8. 3pc Right Pole
9. 4pc Vertical Center Pole

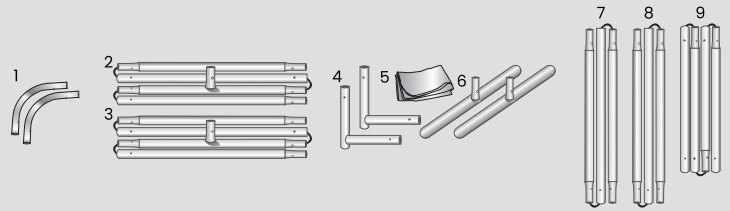

1 Parts Removing

Remove all parts from the carrying case and lay them out on a clean flat surface. Make sure you have all the components listed above.

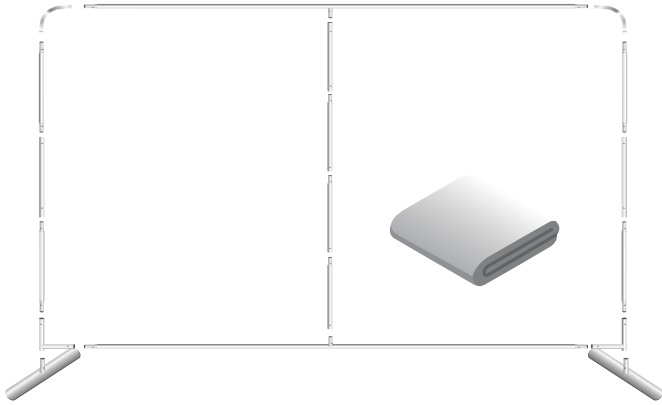

2 Assemble The Frame

Connect all of the poles together by matching each number to its counterpart.

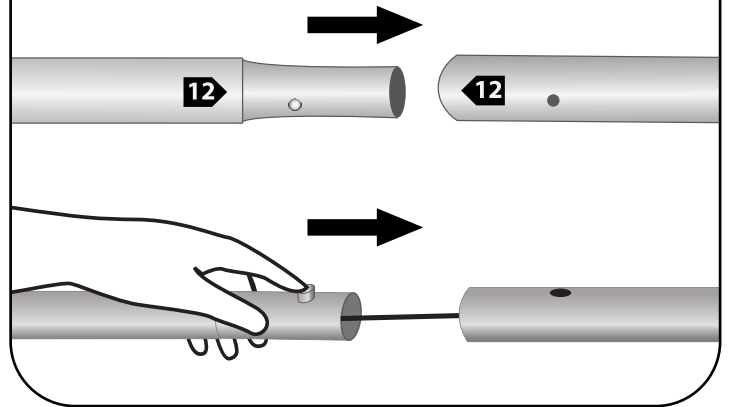

3 Install The Counter Top

Continue to connect the poles illustrated in the image below.

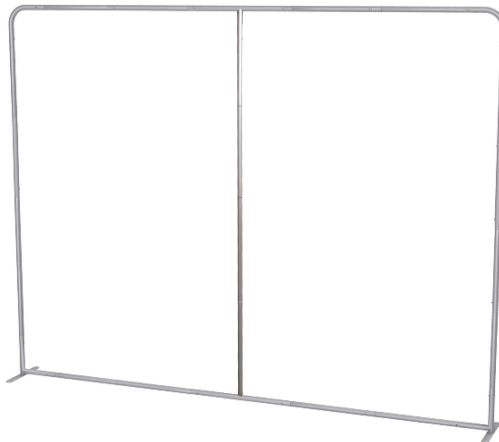

4 Install The Graphic

Pull down the graphic from top to bottom and zip up

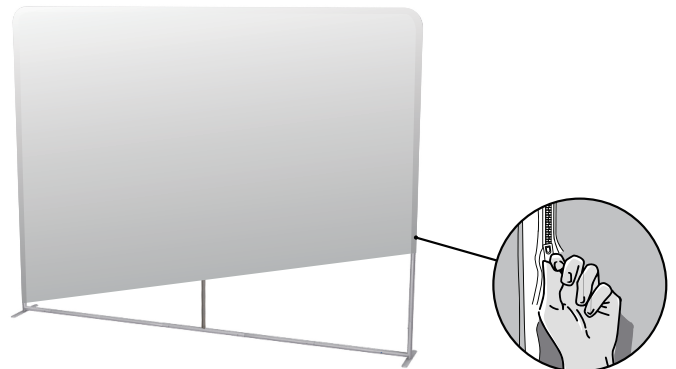

Storage & Care:

Store in a cool dry location. Clean hardware with a damp cloth. Machine wash the graphics in cold water on a gently cycle. Air dry only. Use a steamer for wrinkles. Never dry-clean.

Hard Case Podium

Assembly Instructions



(1) Case Shell
(top)



(1) Case Shell
(bottom)



(1) Counter Top



(4) Poles



(1) Podium Graphic

1 Assemble the Frame

Place Case Shell (bottom) flat on the floor and insert the poles into each of the holes. Then align Case Shell (top) over the poles and press firmly into place.



2 Install Podium Graphic

Starting at the base pull the Podium Graphic the Case Shell (bottom). Then pull up over Case Shell (top), one corner at a time. Adjust and straighten as needed then zip up the back.



3 Install The Counter Top

Place the counter top over Case Shell (top) and press down to ensure the grooves fit over the edge of the case.

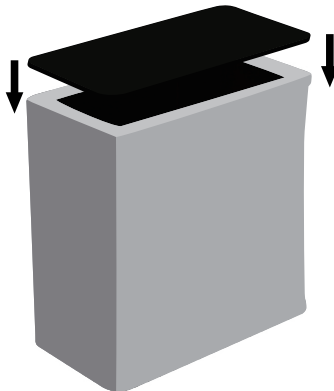

4 Hidden Storage

Use the inside of the podium as an extra storage space for marketing collateral or personal items by unzipping the back and placing items inside.

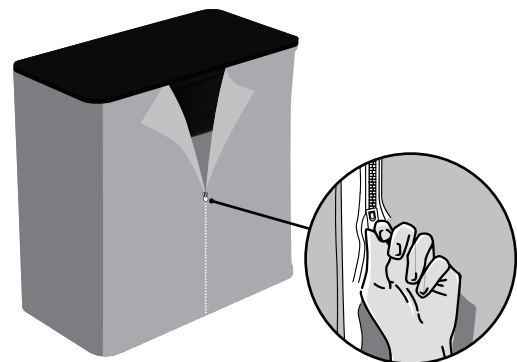

Storage & Care:

Store in a cool dry location. Clean hardware with a damp cloth. Machine wash the graphics in cold water on a gently cycle. Air dry only. Use a steamer for wrinkles. Never dry-clean.

Tension Fabric Header

Assembly Instructions



(2) Side Poles



(2) Top & Bottom Poles



(2) Short Clamps

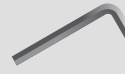

(1) Allen Key



(1) Header Graphic

1 Assemble the Frame

Connect the poles by matching the numbers.

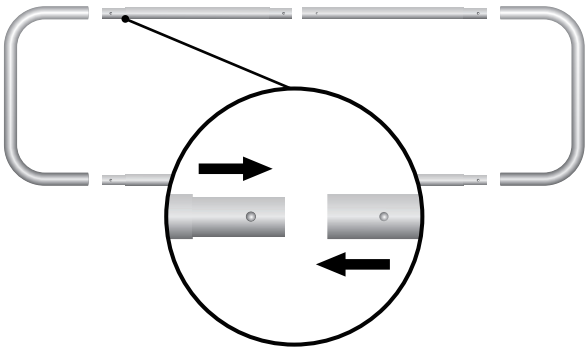

2 Install the Graphic

Carefully pull the graphic print over the frame, ensuring both sides are pulled down at the same time.

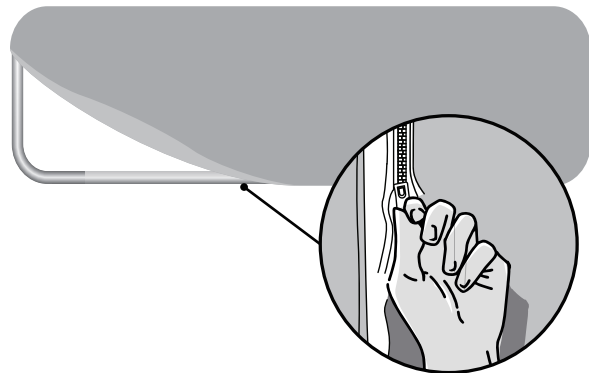

- 3** Lay the header and backdrop flat on the floor. Attach the Header to Backdrop by aligning the header to the desired position on the backdrop and locking into place with the short clamps. (use allen key to tighten everything down)

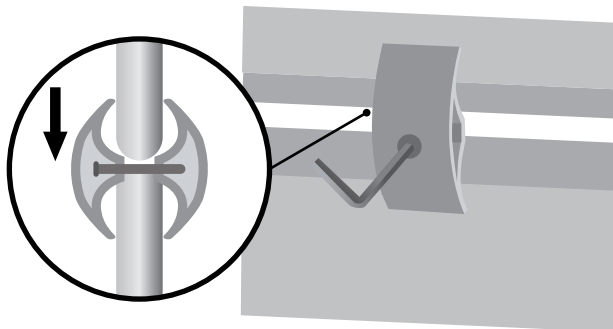

- 4** Carefully lift the backdrop and with header back to the standing position.

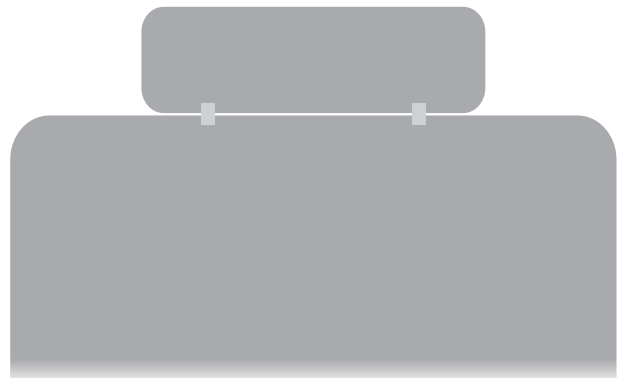

Storage & Care:

Store in a cool dry location. Clean hardware with a damp cloth. Machine wash the graphics in cold water on a gently cycle. Air dry only. Use a steamer for wrinkles. Never dry-clean.

Arch Add-On Assembly Instructions

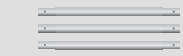

(3) Center Support Poles

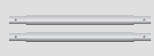

(2) TV Mount Support Poles

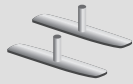

(2) Support Feet

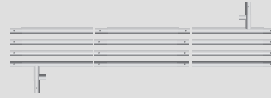

(4) Connected Poles



(2) Corner Poles

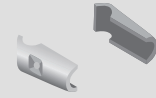

(2) Connected Poles



(1) TV Stand Graphic



(1) TV Mount Main Support



(2) TV Mount Brackets



(8) Metal Washers

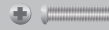

(4) 1" Screws - Thin For TV Bracket



(4) 1" Screws - Thick For TV Bracket

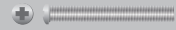

(2) 1.5" Screws - For TV Bracket

1 Assemble the Frame

Connect the poles by matching the numbers. Connect the two sides together with the Center Support Poles and TV Support Poles. Ensure they are tightened securely.

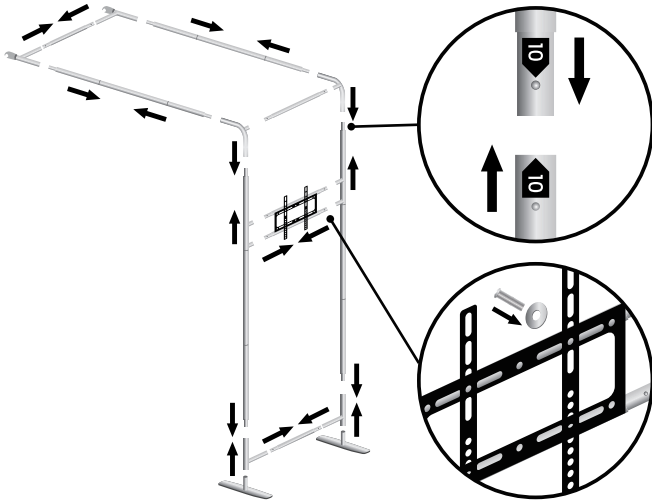

2 Install the Graphic

Carefully pull the graphic print over the frame, ensuring both sides are pulled down at the same time.

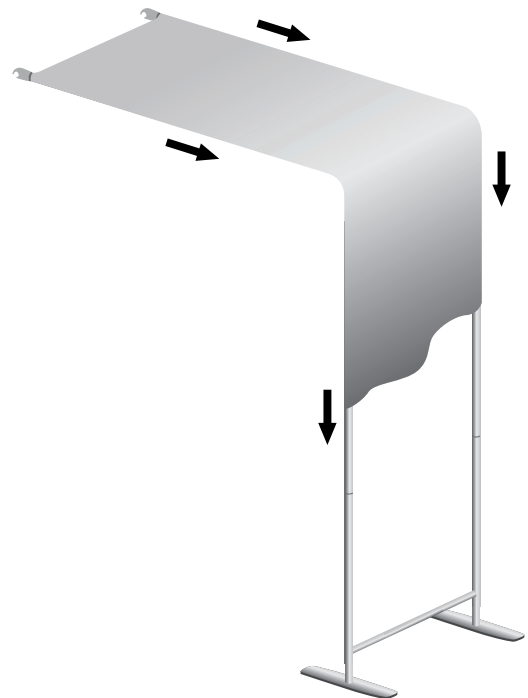

Storage & Care:

Store in a cool dry location. Clean hardware with a damp cloth. Machine wash the graphics in cold water on a gently cycle. Air dry only. Use a steamer for wrinkles. Never dry-clean.

Waterfall Media Rack w/ Shelves

Assembly Instructions

- 1. Connected Poles (2)
- 2. Top Connector (1)
- 3. Crossbar (3)
- 4. End Poles (2)
- 5. Corner Poles (2)
- 6. Shelf Screws (4)
- 7. Shelves (2)
- 8. TV Stand Graphic (1)

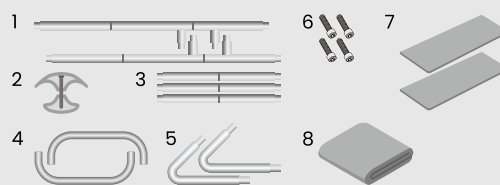

(1) TV Mount
Main Support



(2) TV Mount
Brackets



(8) Metal
Washers



(4) 1" Screws-Thin
For TV Bracket

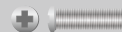

(4) 1" Screws-Thick
For TV Bracket



(2) 1.5" Screws-For
TV Bracket

1 Assemble The Frame

Connect the poles by matching the numbers. Connect both sides together by using crossbars. Connect both top and bottom end poles.

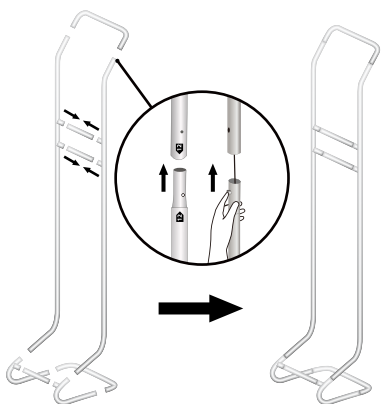

2 Install The Graphic

Carefully pull the graphic print over the frame. Make sure both sides are pulled down together.

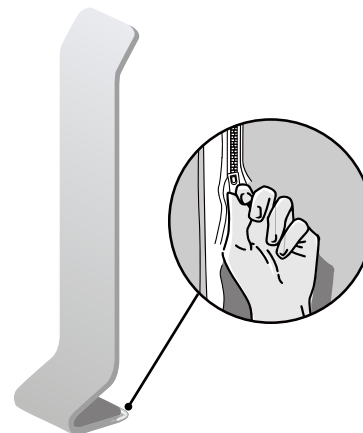

3 Attach to Backdrop

Use the Top Connector piece to attach and secure the Waterfall to Backdrop Frame.

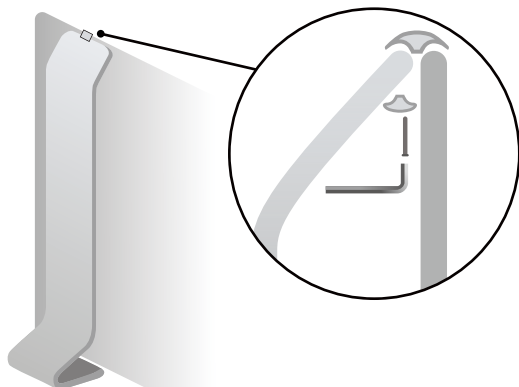

4 Attach TV Mount

Screw the TV Mount on the Waterfall using the 1" TV Mount Screws and Metal Washers.

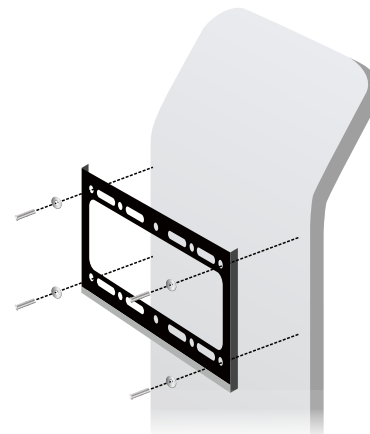

TV Stand Graphic

Assembly Instructions

1. Connected Poles (2)
2. Top Connector (1)
3. Crossbar (3)
4. End Poles (2)
5. Corner Poles (2)
6. Shelf Screws (4)
7. Shelves (2)
8. TV Stand Graphic (1)

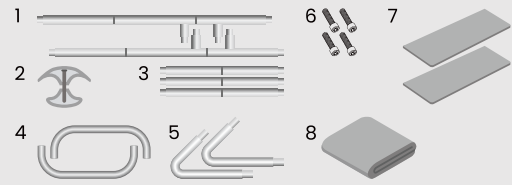

5 Attach The Brackets

Attach the brackets to the monitor using the 1" Thin Screws.

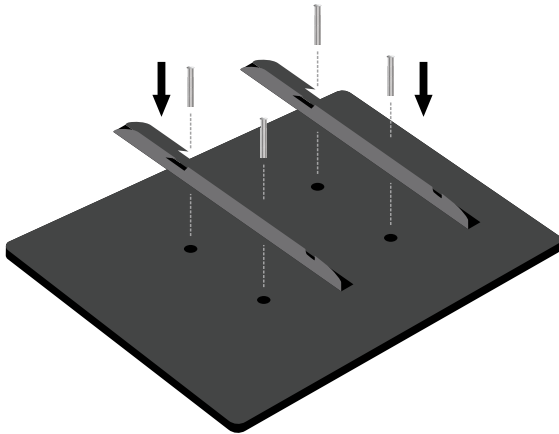

6 Attach The Monitor

Attach the monitor bracket hooks to the top of the monitor mount.

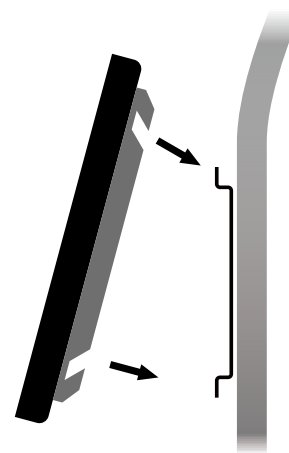

7 Secure The Brackets

Insert the 1.5" screws into the bottom holes of the brackets in order to safely secure the monitor to the mount.

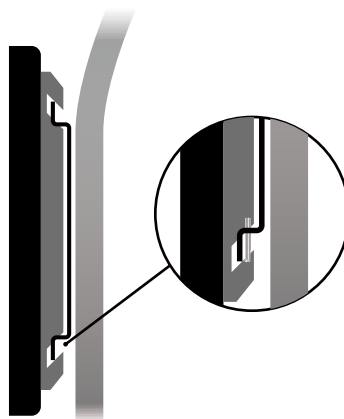

Storage & Care:

Store in a cool dry location. Clean hardware with a damp cloth. Machine wash the graphics in cold water on a gently cycle. Air dry only. Use a steamer for wrinkles. Never dry-clean.

Waterfall Media Rack w/ Shelves

Assembly Instructions

1. Connected Poles (2)
2. Top Connector (1)
3. Crossbar (3)
4. End Poles (2)
5. Corner Poles (2)
6. Shelf Screws (4)
7. Shelves (2)
8. TV Stand Graphic (1)

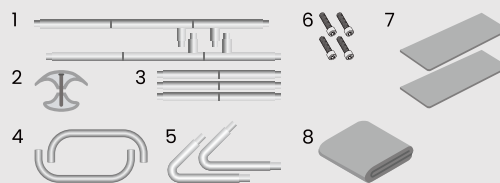

5 Open Both Clamps

Open both clamps on the bottom of the shelves.

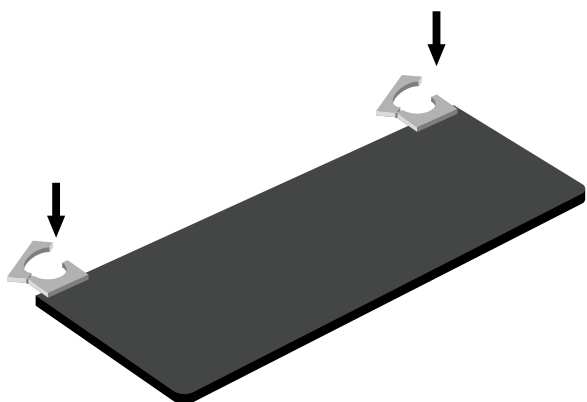

6 Press

Press the shelf and clamp onto the vertical bar (over the fabric).

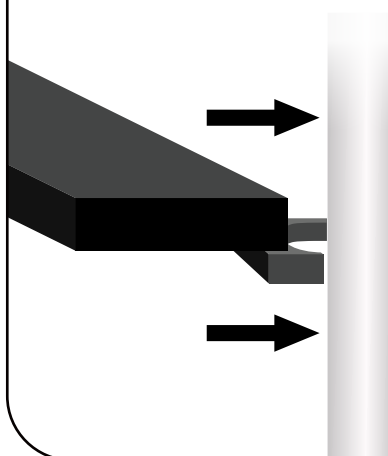

7 Secure The Shelf

Secure the shelf by closing each clamp around the backside of the frame.

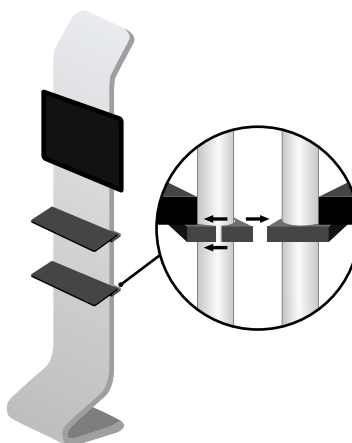

Storage & Care:

Store in a cool dry location. Clean hardware with a damp cloth. Machine wash the graphics in cold water on a gently cycle. Air dry only. Use a steamer for wrinkles. Never dry-clean.

Media Rack

Assembly Instructions

1. Curved Base (2)
2. Corded Vertical Side Poles (2)
3. Top End Cap Pole (1)
4. Bottom End Cap Pole (1)
5. Media Rack Support Pole (1)
6. Media Mount (1)
7. Screw (1)
8. Literature Rack Clips (4)
9. Literature Rack (2)
10. Media Rack Graphic

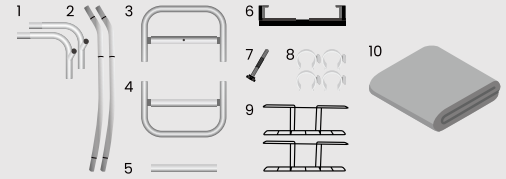

1 Assemble The Frame

Connect the poles by matching the numbers.

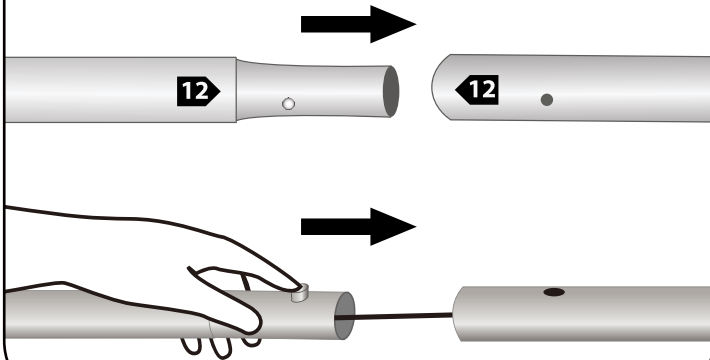

2 Install The Media Rack Graphic

Carefully pull the Media rack Graphic (10) over the frame, ensuring both sides are pulled down at the same time. Zip the end to secure the graphic.

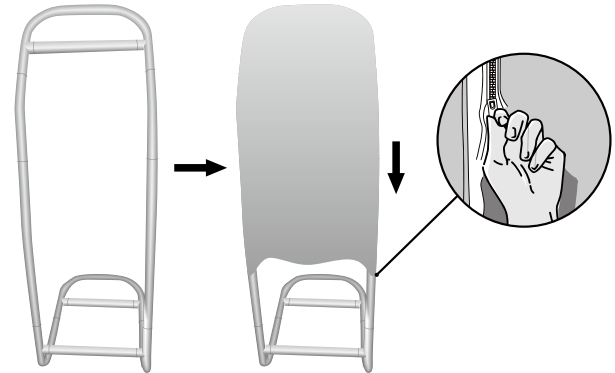

3 Install The Media Mount

Install the Media Mount (6) by running the Screw (7) through the back of the stand, through the hole in the Media Rack Support Pole (5). Tighten Screw into the back of Media Mount to secure in place.

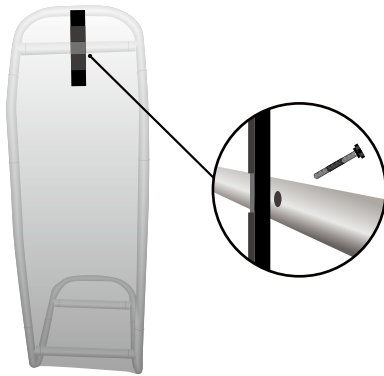

4 Install Literature Rack Clips

Install Literature Rack Clips (4) on each of the side bars. Hand Literature Rack from the clips.

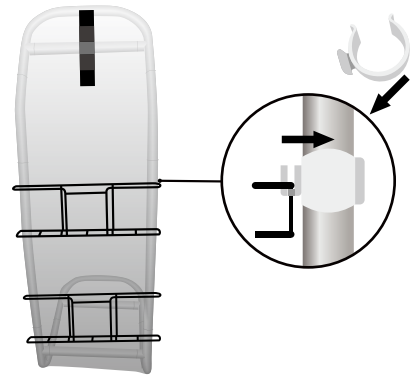

Storage & Care:

Store in a cool dry location. Clean hardware with a damp cloth. Machine wash the graphics in cold water on a gently cycle. Air dry only. Use a steamer for wrinkles. Never dry-clean.